

Systemec SP = highly dynamic





Think green – act blue!

**BlueTechnolution**

Only if you can derive the maximum benefit from our solutions for your production process at all times, we have achieved our goal: Injection moulding machines from Sumitomo (SHI) Demag combine energy and production efficiency in an ideal manner. This helps you improve cycle times, save resources and at the same time reduce your carbon footprint.

**Trust in technology**

In production solutions from Sumitomo (SHI) Demag, performance, economic viability and responsibility for our environment always go hand in hand. The benefits we offer to you are decades of experience in all injection moulding technologies and particular efficiency of our machines.

**Market and machine requirements**

As a pioneer and innovation driver in the area of injection moulding, we know the exact requirements posed by the markets and industries. This allows us to optimise your production using application-oriented and efficient machine solutions.

**Systemec SP – the highlights:**

- Systemec SP is a injection moulding machine with hybrid drive concept, optimised for maximum performance and highest energy efficiency.
- Due to its robust construction, Systemec SP has a record of excellent long-term production – with minimum maintenance costs.
- The integrated activeMotionControl drive technology ensures high dynamics, precision and availability for long-term, daily production.
- The newly developed machine concept of Systemec SP, based on that of El-Exis SP, is optimally designed for the high requirements in the packaging industry.
- The optimised NC5 plus control allows easy and intuitive handling.

Our hybrid drive concept allows up to 60 per cent energy saving during operation. And because we are aware of our responsibility for the environment, the modern hybrid servo drives feature all new developments from Sumitomo (SHI) Demag.

The new Systemec SP series with its extremely high production and energy efficiency sets the benchmark against which all our future developments will be measured.



### Efficiency – the measure of all things

Decades of development brought Sumitomo (SHI) Demag the most advanced technologies in all areas of injection moulding. Our products are characterised by high energy and production efficiency.

Energy and resource consumption are still the key cost factors in the production of plastic products. With its BlueTechnology products Sumitomo (SHI) Demag could significantly reduce energy consumption and its carbon footprint in the area of injection moulding.

While developing our products, we have had the opportunity to acquire a very good knowledge of the requirements of different industrial sectors. This is why we can offer you optimum product solutions which due to their particular efficiency increase your profits and reduce costs long-term.

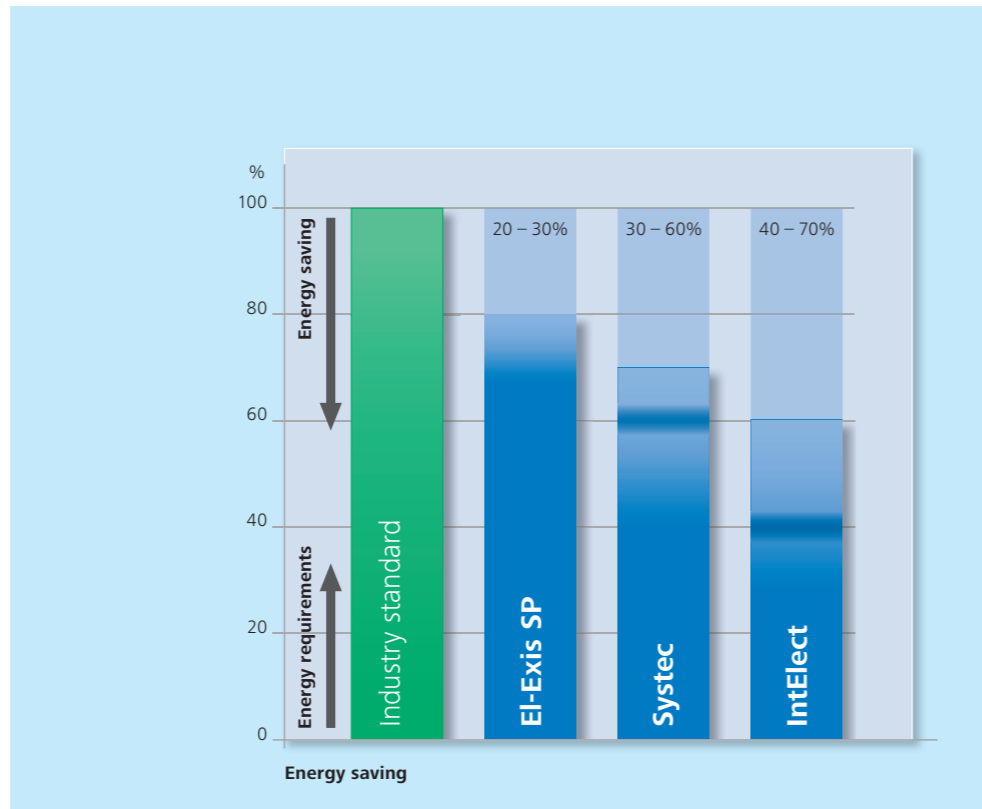

### The basis for your individual solution

All our products use the same global platform as a basis. This platform can be adapted to almost all special customer requirements and it can be further developed to an industry-optimised production cell.

The hybrid and hydraulic technologies realised in our product series Systec and EI-Exis give you the advantage of many

years of engineering experience from our German development sites.

The all-electric IntElect injection moulding machines use the know-how acquired by our Japanese parent company in the course of development and production of 50,000 machines which have been delivered to the customers.



### Systec – multi functional

The hydraulically driven injection moulding machine Systec is extremely energy-efficient and almost always allows a very flexible adaptation to the requirements – the options range from the well-equipped basic version to the individually configured production cell.

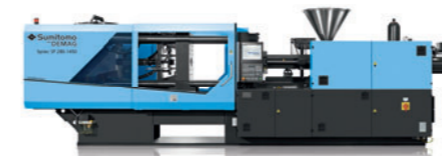

### Systec SP – highly dynamic

Systec SP is equipped with a hybrid drive system and is particularly suited for applications in packaging production. Short cycle times and high availability provide the ideal solution for many quick applications.



### EI-Exis SP – incredibly fast

With extremely short cycle times and the shortest injection times EI-Exis SP is the ideal machine for the application in the high end packaging production. The machine convinces with its robustness and extreme filling dynamics.



### IntElect – highly precise

An all-electric injection moulding machine characterised by its high precision and energy efficiency. Low operating costs are what makes IntElect particularly efficient. The machine was built based on Sumitomo's unique know-how in the development of all-electric drive systems.

## Always the best solution – for your requirement

### Requirements compared between the industries

Be it automotive industry, production of white goods, medical equipment, electronics or packaging sector, every industrial sector has its special requirements.

However, quality as well as efficient and resource-saving processes play an important role in all sectors.

A long-term profitable balance between investment, production volume and consumption costs must be ensured.

With its product line Sumitomo (SHI) Demag covers the requirements of all industrial sectors and with Systec, Systec SP, IntElect und EI-Exis SP series provides a suitable machine for your individual product.

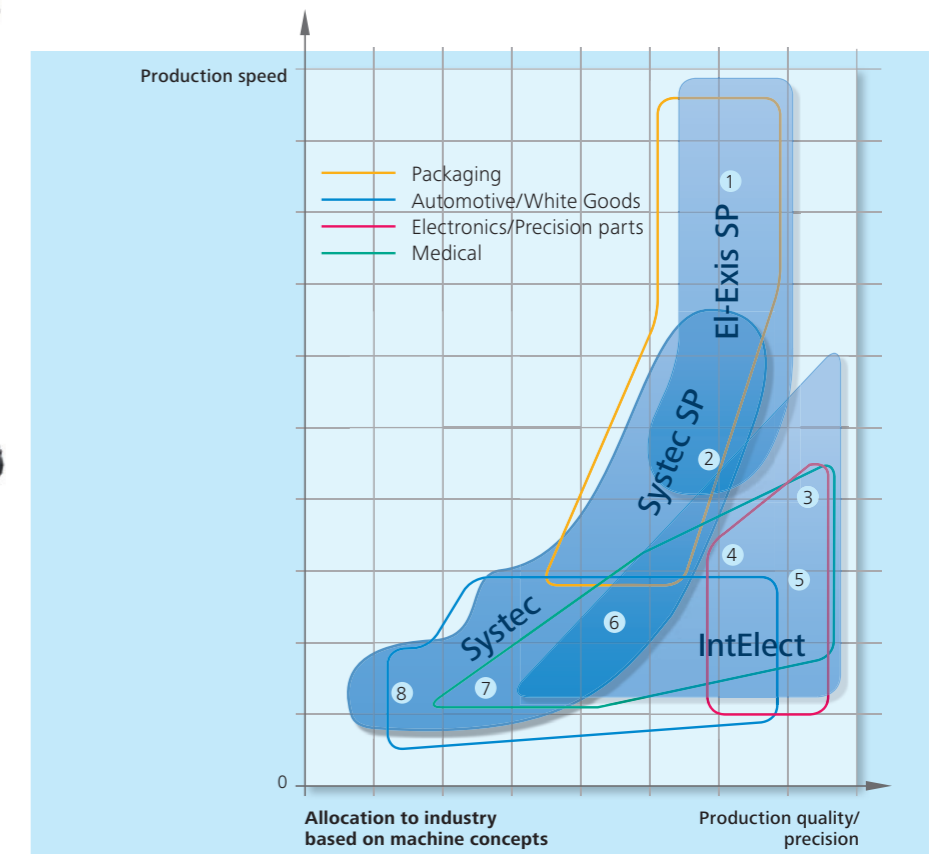

- 1 Standard caps, thin-walled products
- 2 Covers, customized closing systems, flip tops, buckets, reservoirs
- 3 Microparts and precision parts
- 4 Pharmaceutical packaging components, pipettes, syringes, cosmetic products
- 5 Plugs, switches, fasteners, gear wheels, optical parts
- 6 Automotive interiors, technical parts, white goods
- 7 Enclosures, vehicle parts "under the hood", instruments
- 8 Toys, household articles, office supplies

# Systec SP – speed performance making your production even more efficient



## Systec SP – precision and speed as a unity

Sophisticated packaging solutions that must be produced quickly and in great quantities are a big challenge for the injection moulding technology.

Systec SP machine series has been developed for the special requirements of the packaging industry. If you produce buckets, flip tops, stacking boxes or covers, Systec SP is always a good choice. Thanks to our longstanding experience in injection moulding of thin-walled containers and standard caps, injection processes can be realised with Systec SP within 4 to 12 seconds in the most efficient way.

Equipped with the innovative standard drive system activeDrive combining a frequency-regulated high-performance engine with a hydraulic pump, Systec SP works faster and is more energy efficient than its counterparts.

- Hybrid, servo-hydraulic drive system for parallel movements and short cycle times
- Energy-optimised hydraulic accumulators allow high injection speeds
- Servo-position control for fast and precise injection
- Electric high torque direct drives for a high plastification output
- Highly sensitive mould protection for maximum operational safety

|           | Clamping force [kN] | Clear distance between tie bars [mm] | Injection units    |
|-----------|---------------------|--------------------------------------|--------------------|
| Systec SP | 1600                | 520 x 520                            | 430 / 600 / 840    |
|           | 2100                | 580 x 580                            | 600 / 840 / 1450   |
|           | 2800                | 630 x 630                            | 840 / 1450 / 2300  |
|           | 3500                | 720 x 720                            | 840 / 1450 / 2300  |
|           | 4200                | 820 x 820                            | 1450 / 2300 / 3300 |

## More performance, less consumption costs

All Systec SP series machines are equipped with the energy-saving hybrid drive activeDrive concept and activeMotionControl control technology.

With faster axle movements and a highly dynamic injection technology this innovative system significantly increases its output rate, while clearly reducing energy consumption. The greater dynamics of the driven axles during the injection movement allow very short filling and switching times, thus directly influencing the quality of the manufactured parts.

Thus, with Systec SP you not only increase the quality, cost-effectiveness and economic viability of your production, but also save resources and the environment. Moreover, the extremely smooth operation of the machine is highly appreciated by users.



Think green – act blue: Taking its lead from this slogan, Sumitomo (SHI) Demag is developing new technologies and lives up to its responsibility for our environment. The result are machines convincing both with production and energy efficiency.

Our success proves us right: As of now, we could deliver more than 10,000 production solutions in the high-speed segment. Our new Systec SP series will be the continuation of this successful development.

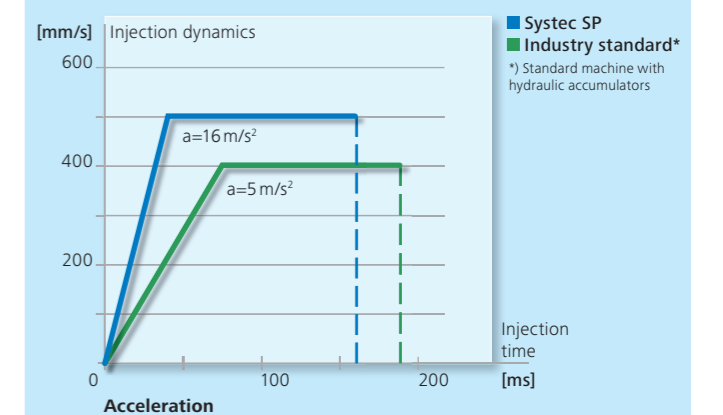
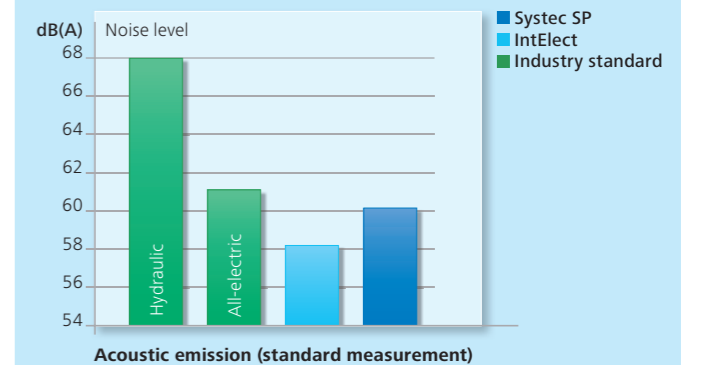
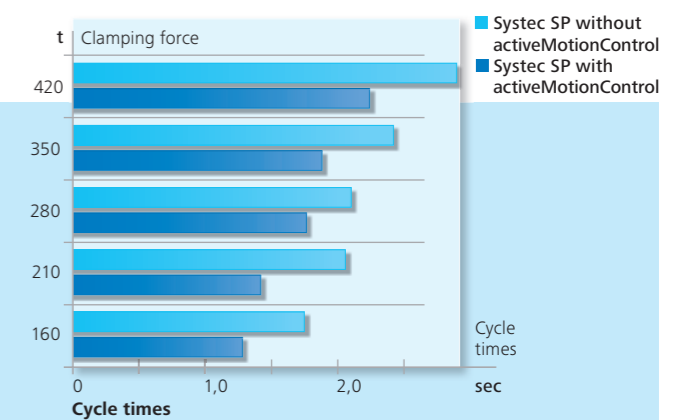

# System SP 160 – 420 t

## activePowerLink

Low energy costs for high power and quick movements. Locks exactly, quickly and energy-efficiently

## activeAdjust

Cycle optimisation through individual regulator adjustment for ejector, closing movement and injection. Ensures a smooth, harmonic machine operation even under extreme conditions

## NC5 plus control

Intuitive, process-oriented user interface for comfortable setting, monitoring and recording

## activeMotionControl

Drive system which is precisely tuned to the machine allows higher manufacturing quality and reproducibility with shorter cycle and filling times

## High-speed servo valve with position control

Highly dynamic acceleration and deceleration for short filling times and highly dynamic switching to holding pressure

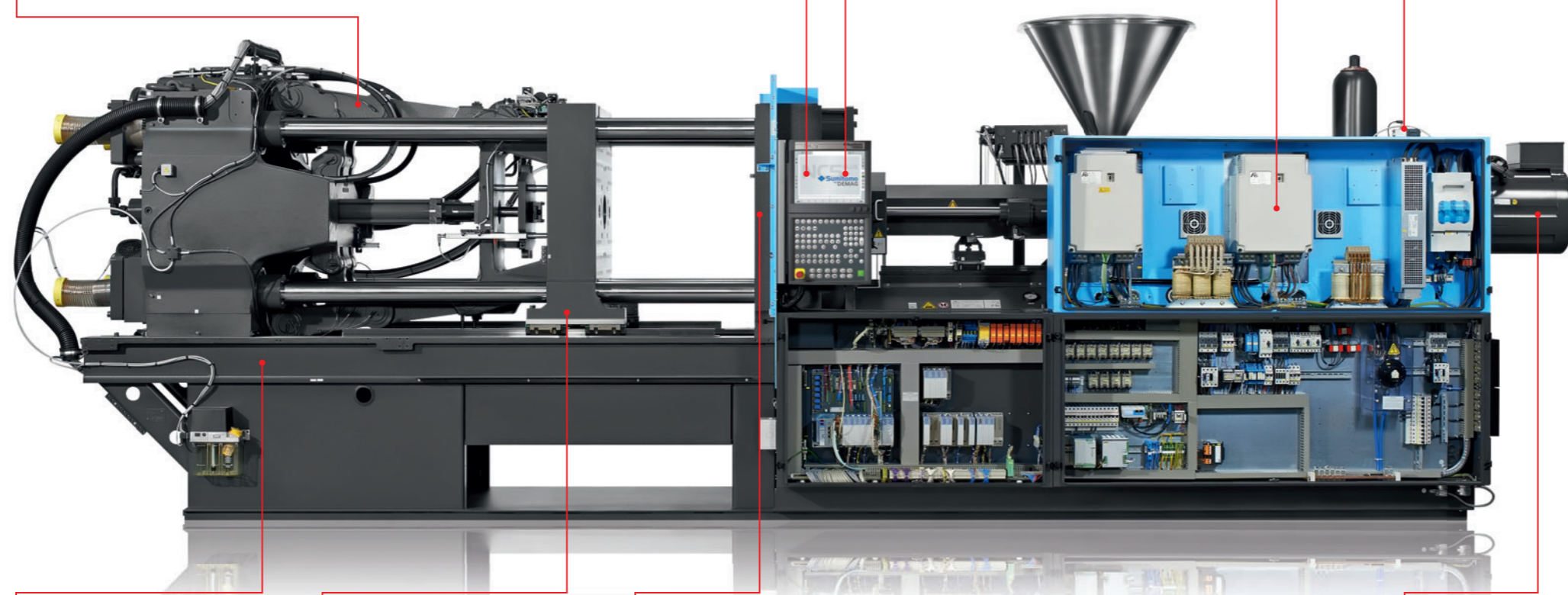

## Reinforced machine base

Machine base sagging is avoided. This gives stability to the whole construction and allows high precision of mould movement during production process

## activeGuide

Standard linear guiding of the movable platen ensures the highest precision, reduces mould wear and cycle times

## Platen

High stiffness over the entire platen surface guarantees the highest stability

## activeScrewDrive

Decentralised, electrical screw drive for parallel dosing and high dosing capacity



High-speed servo valve with position control



activeScrewDrive

# System SP 160 – 420 t

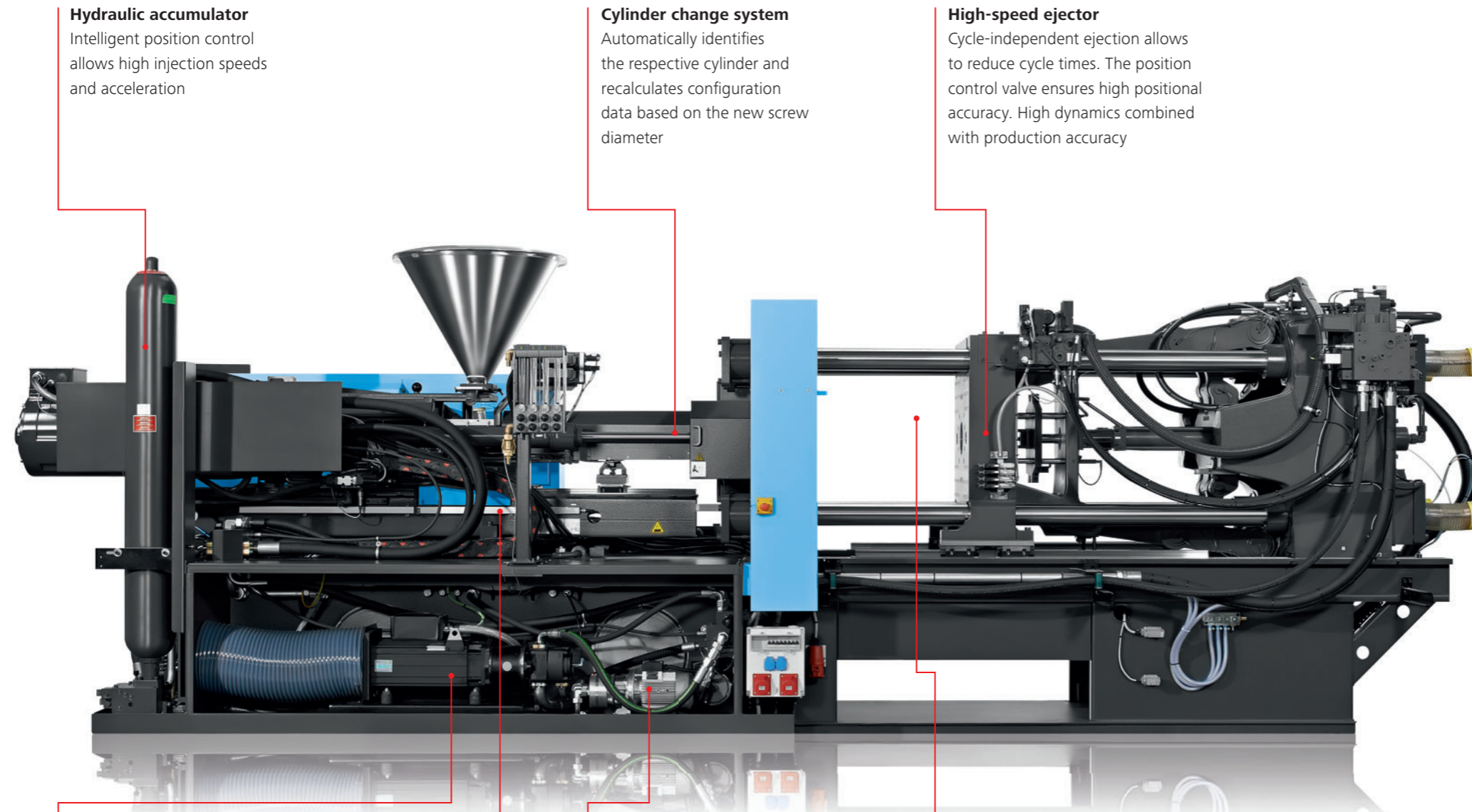

**Hydraulic accumulator**  
Intelligent position control allows high injection speeds and acceleration

**Cylinder change system**  
Automatically identifies the respective cylinder and recalculates configuration data based on the new screw diameter

**High-speed ejector**  
Cycle-independent ejection allows to reduce cycle times. The position control valve ensures high positional accuracy. High dynamics combined with production accuracy

**activeDrive**  
The activeDrive component allows an energy saving of up to 60 per cent compared to the conventional hydraulic drives

**Screw cylinder**  
Constant L/T ratio (20:1 and 25:1) for an equal melt quality, good coloration and an easy replacement of the injection cylinder

**activeCool&Clean**  
Superfine filtration of oil and an oil change interval of 40,000 operating hours contribute to the constant high operational safety of the machine

**activeQ/Q+ (Q+ = optional)**  
The highly sensitive, active mould protection detects every error over the entire opening and closing stroke of the clamping unit. Automatic deceleration of the clamping unit reduces response times to a minimum

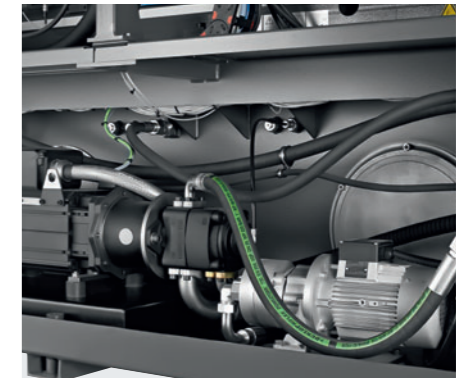

activeDrive and activeCool&Clean



High-speed ejector with position control

# Production efficiency ActivePlus

## activePlus – intelligent solutions with maximum effect

With Systec SP, the greatest possible efficiency is no longer just a pipe dream: with a wide range of innovative and well-tried technologies, the specialists from Sumitomo (SHI) Demag can optimally

adapt Systec SP to suit your needs. Because you surely know it from your own experience: your investment in a new machine only pays off if the highest production output can be achieved along with the maximum operational effectiveness.

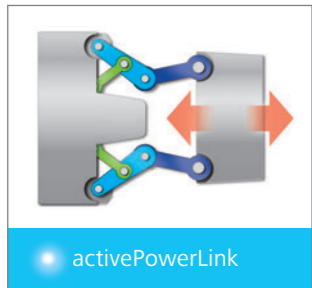

activePowerLink

### activePowerLink

Low energy costs for high power and quick movements. Exact, quick and energy-efficient locking



activeCool&Clean

### activeCool&Clean

Extends oil change intervals and reduces wear of hydraulic parts significantly

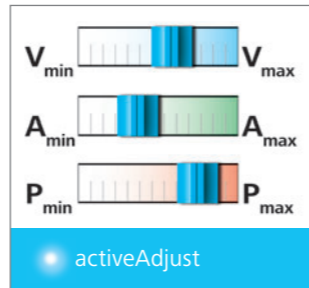

activeAdjust

### activeAdjust

Individually adjustable axis controller characteristics to optimise dynamics and accuracy of cycle

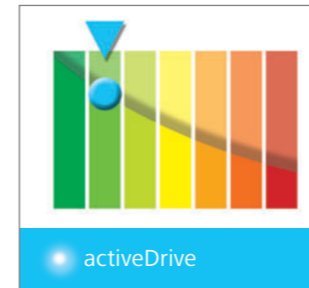

activeDrive

### activeDrive

Allows high dynamics and short cycle times at up to 60% energy efficiency compared to standard drives

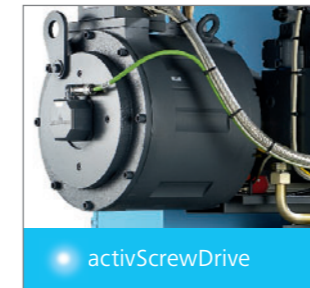

activeScrewDrive

### activeScrewDrive

Higher efficiency factor due to powerful direct drive. Parallel dosing reduces the cycle times



activeGuide

### activeGuide

The highest quality of moulded parts due to platen parallelism and reduced mould wear



activeRemote

### activeRemote

Intuitive operation of the machine and peripheral equipment due to process visualisation through NCS plus control

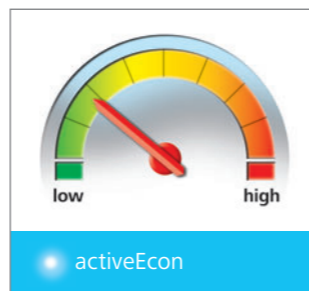

activeEcon

### activeEcon

Visualisation and optimisation of process settings with regard to energy consumption and production costs

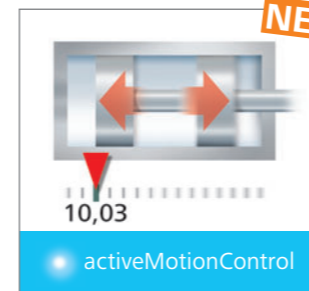

activeMotionControl

### activeMotionControl

Higher production quality and reproducibility due to the newly developed axle control system. The drive system is exactly tuned to the machine. This allows you to reduce filling and cycle times



activeQ/activeQ+

### activeQ/activeQ+ (Q+ = optional)

Sensitive and fast-responding mould protection for highest operational safety and minimum maintenance costs

## Production efficiency activePlus

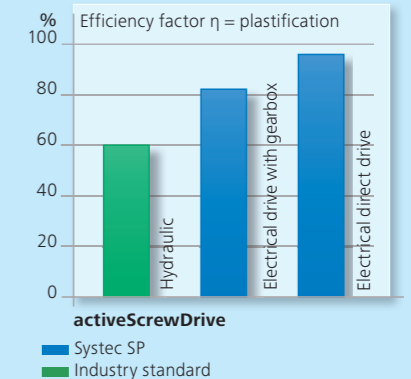
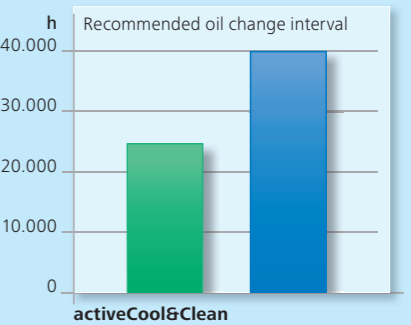
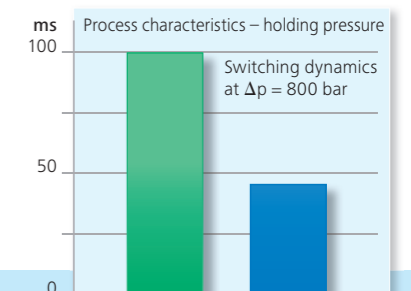

### Our production efficiency components for your benefit

With its multiple production efficiency components Systec SP stands above all industrial standards. The innovative drives from Sumitomo (SHI) Demag provide significantly enhanced performance. The lower consumption costs and the reduced maintenance costs will pay off in the long term.

# NC5 plus – everything under control



The well-tried NC5 plus user interface for Systec SP is now even more intuitive and offers even more options to individually influence the production process.

### Your benefit

- Easy operation and quick familiarisation with NC5 plus user interface
- Well-arranged screen structure, clear soft key layout and hiding of unused functions reduce setup and optimisation times
- Danger of overfeeding is reduced by direct input of injection pressure profile and automatic purging of plastic melt after longer downtime periods (time can be adjusted)
- Extended options for process optimisation: activeAdjust can be applied for any machine movement (clamp movement, switching from injection pressure to holding pressure)
- Avoidance of mould damage through active mould protection during the closing and opening movement of the mould activeQ/activeQ+
- Transparent process time analysis through saving of reference cycle with graphical display of nominal/actual temperature



### Double-click strategy allows quick navigation

- Access to every page by maximum two clicks
- Easy search function
- Logical division in main groups and subgroups allows to accelerate processes significantly.

### Fast selection from Favourites optimises navigation

- “activeKeys” for the direct selection of five screens which are accessed most frequently
- Icons which can be clearly defined by the user

### User-friendly soft key structure

- Quick navigation through soft keys
- Functional groups with logically related screen contents

### activeAdjust: Individual setting options

- Functional variety with slide control
- Increase or reduction in the dynamics of mould movement for individual applications
- Optimum individual setting for process and product

### Injection pressure monitoring

- Injection pressure progression can be saved as reference curve
- Monitoring of reference curve with selectable tolerances
- Machine responses can be set from tolerance monitoring

### Mould protection curve

- Graphical presentation of force progression
- Force limitation during mould closure through monitoring of reference curve
- Adjustable in 2 steps
- Adjustable startup programme



## Our customer service – your daily safety



### Our services – your benefits:

- Guaranteed operational readiness of your plant on the agreed date
- Competent support due to the best-trained service staff
- Competent and optimum service hotline
- Smooth spare part supply due to high storage capacities, maximum flexibility and tight-knit logistics network
- Comprehensive retrofit programme will keep your plant always up-to-date
- Professional training courses for the efficient training of your employees

» *Our goal is the perfect performance of your plant. From the very first day, with any capacity utilisation, for many years.* «

Reinhold Ganzer, customer support management, Sumitomo (SHI) Demag

The perfect performance – from the very beginning. Injection technology is more than productivity. What counts is the certainty that innovations will quickly and safely pay off. We take the responsibility for that.

### Replacement parts

The high storage capacity, high flexibility and tight-knit logistics network guarantee the fastest processing and the shortest delivery times – worldwide.

### Service

From the first entry into service, qualified support during operation and tests through to the service hotline: we are ready to provide competent assistance wherever it is required.

### ErgoCheck – Security made to measure

We check your machines with the greatest care. In regular intervals or whenever you need. ErgoCheck checks both all quality-relevant process parameters and all basic and safety functions and provides tested safety to you and your customers.

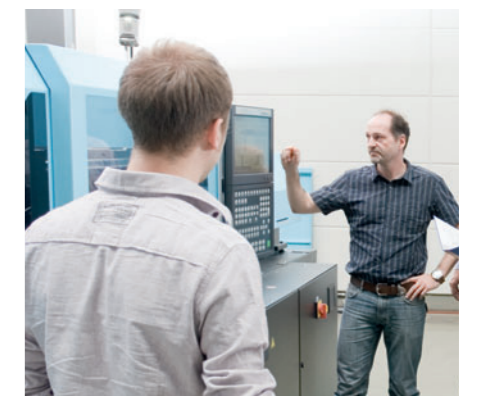
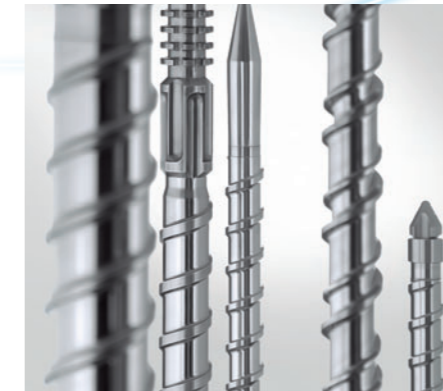

### Retrofit

Sustainability and economic viability par excellence – our comprehensive retrofit programme allows, for example, to meet new technical challenges with handling upgrade or special software for different processes and operations. Energy saving solutions, an additional injection unit (multi-plug), a hot runner control or other innovative functional extensions keep you up-to-date at all times.

### Training

The modular training programme from Sumitomo SHI Demag stands for tailor-made training of your employees in all relevant areas: machine operation, process technology, machine technology and automation.

Ready for the future

# Blue TECHNOLUTION®

## Maximum efficiency for every application

For Sumitomo (SHI) Demag, environmental awareness and environment-friendly action go hand in hand with the most advanced application-oriented technologies in all areas of injection moulding. All our machines are characterised by high energy and production efficiency.

All technologies from Sumitomo (SHI) Demag are designed to offer the maximum benefit to the customer. With our extremely robust, flexible and powerful machines we increase your productivity in the production of high-quality plastic components and at the same time reduce resource consumption and operating costs.

## Advanced technology

Until now, Sumitomo and Demag, have delivered more than 100,000 injection moulding machines for almost every application and requirement. As early as in the 1990s Sumitomo was the driving force behind the development and production of all-electric injection moulding machines and is now the worldwide market and technology leader. The customers particularly appreciate our individual, made-to-measure solutions and the sustainable, efficient operation of our machines.

Both Systec SP as well as El-Exis SP have been specifically developed based on the requirements of the packaging production and can be perfectly integrated in your processes. Higher performance and extreme operational safety with drastically reduced resource consumption and minimum maintenance costs will pay off in the long term.



*» We offer the most advanced and efficient technical solutions. At the same time we live up to our responsibility for the environment. «*

Dipl.-Ing. Christian Renners, CSO



Sumitomo (SHI) Demag Plastics Machinery GmbH  
info-dpde@dpg.com  
www.sumitomo-shi-demag.eu

Although all data and information contained in this leaflet were compiled with the utmost care, we cannot accept liability for their accuracy.  
We furthermore point out that individual pictures and information can deviate from the actual delivery condition.